

COMMAX



User Manual

VIDEO DOOR PHONE CAV- 71B

COMMAX Co.,Ltd.

513-11, Sangdaewon-dong, Jungwon-gu, Seongnam-si, Gyeonggi-do, Korea
Int'l Business Dept. : Tel.; +82-31-7393-540~550 Fax.; +82-31-745-2133
Web site : www.commax.com

Printed In Korea / 2010.04.101



- Thank you for purchasing COMMAX products.
- Please carefully read this User's Guide (in particular, precautions for safety) before using a product and follow instructions to use a product exactly.
- The company is not responsible for any safety accidents caused by abnormal operation of the product.

Table of Contents

1. The Function and Name of each Part	2
2. Features and Main Function	3
3. Package	4
4. System Layout	4
5. Wiring Diagram	5
6. Installation Method	6
7. Operating Description	7
Visitor Call & Monitoring	
Interphone Function	
Burglar Function	
Review Function	
Product Setting	
8. Check Point in Trouble	12
9. Specification	13

Warnings and caution

⦿ Make sure to follow the instructions to prevent any danger or property losses.



Warning Death or serious injury is expected.

- It indicates prohibition.
- It indicates prohibition of disassembly.
- It indicates prohibition of contact.
- It indicates dos and don'ts.
- It indicates that the plug should be pulled out from the socket.



Warning

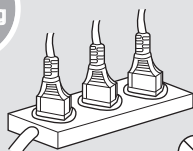

Prohibition

Do not put the plug in the socket simultaneously.

It may generate abnormal heat or cause a fire.

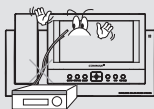

Prohibition

Do not connect to other products while in use.

It may cause breakdown.



Prohibition

Do not forcibly bend the cord or put a heavy object on the product.

It may cause a fire.

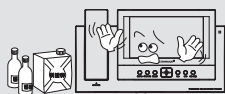

Prohibition

Do not use water, thinner or a detergent used to wash oil products when you wash the exterior.

Make sure to wash it by using a dry cloth to prevent any breakdown or electric shock.



Prohibition

Do not install the product in a humid place.

It may cause an electric shock or a fire.



Prohibition

Do not forcibly pull out the cord from the socket.

If the cord is damaged, it may cause a fire or an electric shock.



Do not contact.

Do not put the plug in the socket with a wet hand.

It may cause an electric shock.



Do not disassemble

Do not disassemble, repair or modify the product.

It may cause a fire, an electric shock or an injury due to malfunction of the product.

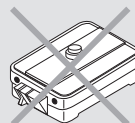

Do not use AC circuit breaker.

It may cause an electric shock.

Warnings and caution



Caution An injury or property losses are expected

- It indicates prohibition.
- It indicates prohibition of disassembly.
- It indicates prohibition of contact.
- It indicates dos and don'ts.
- It indicates that the plug should be pulled out from the socket.



Caution

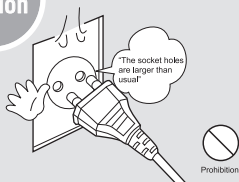

If the socket holes are larger than normal, do not put the plug.
It may cause an electric shock or a fire.



Make sure that dust or foreign substances are not gathered on the product.



Make sure to prevent foreign substances from entering the product.
It may cause a breakdown.



Do not put a heavy object on the product.
It may cause a breakdown.

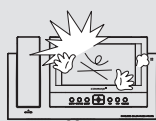

Do not disassemble or give an impact to the product.

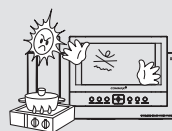

Avoid direct rays of the sun or heating devices at a time of installation.

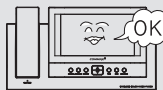

Install the product in a flat and stable place.
Otherwise, it may not function properly.



Pull the plug if the product is not used for a long time.

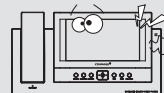

If the product generates strange sound, make sure to pull the plug immediately and contact Commax service center.



1. The Function and Name of Each Part

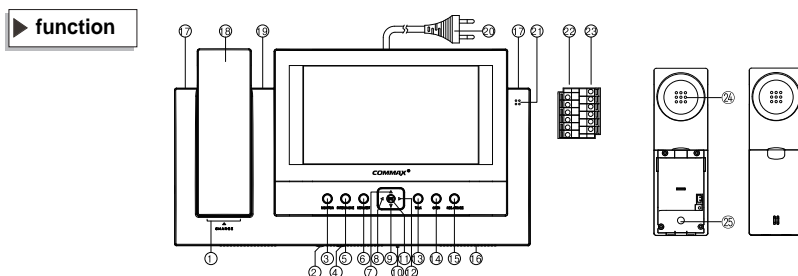

No.	Name	Details
1	Charging terminal	
2	Volume for call volume control	Control the call volume.
3	Monitor button	View the screen by door camera or talk.
4	Volume for talk volume control(H/F)	Control the talk volume.
5	Interphone button	Talk by interphone between the rooms.
6	Menu/Set button	Burglar, Room ID, Interphone receiving rejection and RF ID are set.
7	Up button	Up direction key
8	Left button	Left direction key
9	Down button	Down direction key
10	Power supply switch	Control the power supply of product.
11	Enter button	Execution button
12	Right button	Right direction key
13	Talk button	Talk in calling over the door and interphone.
14	Open button	Operate on Door release of door camera.
15	Record button	Record the screen of camera.
16	Speaker	Talk voice and call voice is spoken.
17	Chargingmode power lamp	Display that charging condition of handset is normal.
18	Handset	Wire type(CAV-71B)
19	Burglar/Automatic video recording lamp	Red lamp in burglar set, Green lamp in automatic video recording is flashing.
20	Power source code	Supply power source of product. (AC100V-240V Free-voltage)
21	Microphone	Send the voice in hands free talk.
22	Input terminal(INPUT)	Terminal for input in connecting.
23	Output terminal(OUTPUT)	Terminal for out in connecting.
24	Handset Speaker	
25	Handset mike	



2. Features and main Function

1. Features

- 7" WIDE TFT-LCD
- Surface mount type installation method
- FREE VOLTAGE power supply
- Menu control by on screen display(OSD)
- RF(2.4GHz) Wireless handset

2. Main function

- Interphone call and talk function
- Image storing (128 cut) function
- Burglar function
- Door Open Function
- CCTV interworking
- 4 Door units & 20 Room station connectable.

3. Package

▶ images

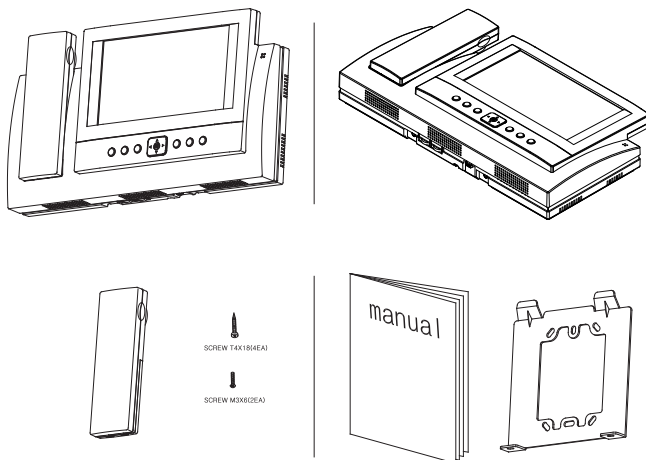

- Monitor unit : CAV-71B
- Wireless Handset
- User manual
- Wall Bracket
- Fixing Screw

4. System Layout

▶ images

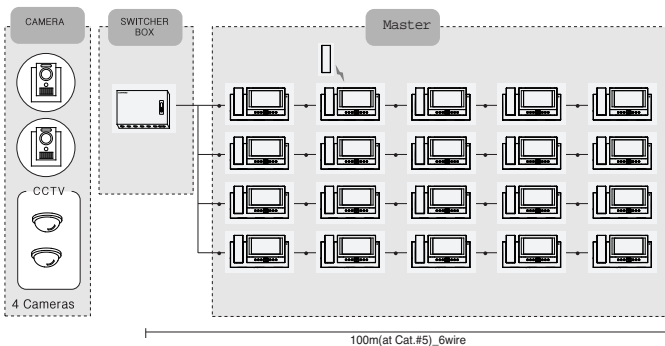

- The number of door camera connection: 4 units (Max.)
*CCTV Camera connectable
- The number of household monitor connection: 20 units (Max.)

5. Wiring Diagram

▶ images

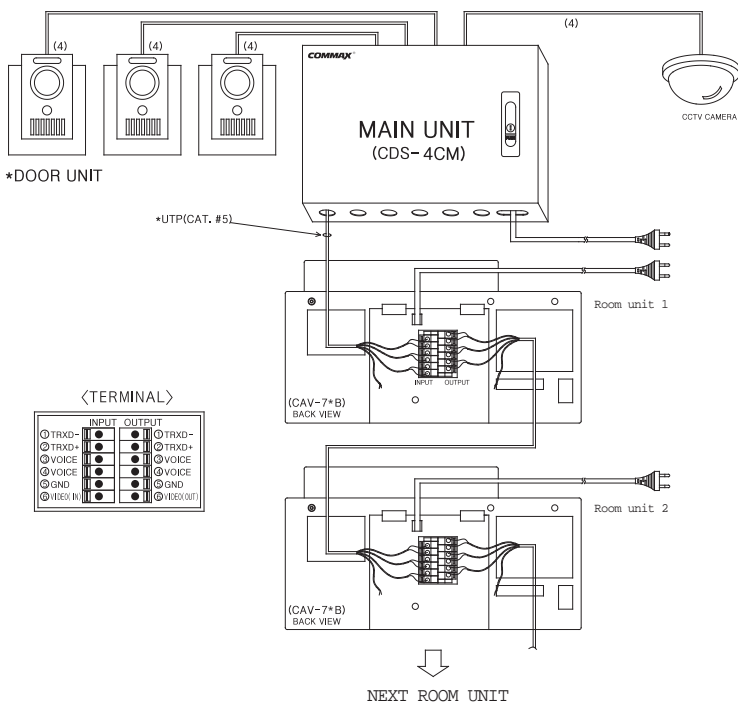

<TERMINAL>

INPUT		OUTPUT	
⊙ TRXD-	⊙ TRXD+	⊙ TRXD-	⊙ TRXD+
⊙ VOICE	⊙ VOICE	⊙ VOICE	⊙ VOICE
⊙ GND	⊙ GND	⊙ GND	⊙ GND
⊙ VIDEO IN	⊙ VIDEO OUT		

- Notes for connecting
 - ..Maximum number per line from the slave connection terminal of main unit is 5.
 - ..Please connect wiring terminal carefully on polarity.
 - ..Please use UTP (CAT. 5) for cable and 14~24AWG for others.

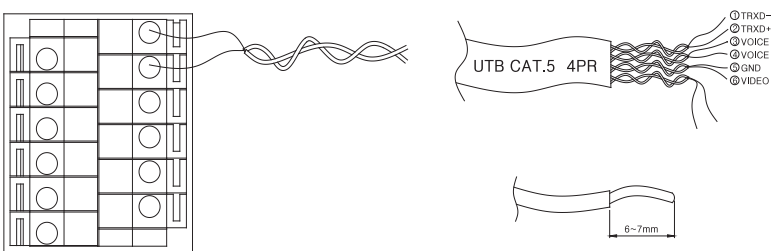



6. Installation method

▶ Installation method of monitor

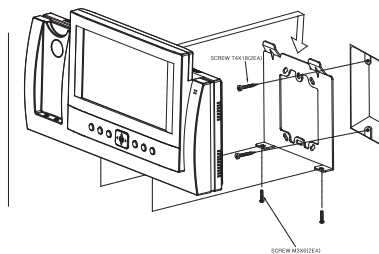
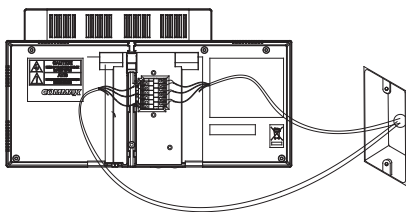

- Notes for installing

- Please keep the product away from a magnetism, severe moisture, and direct ray of the sun and nearby heater, which may influence on the product.
- Suitable height for main unit is 1450~1500mm from the bottom to the screen.
- Please arrange the handset after installation completed.

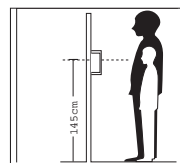

▶ Installation method of camera (at DRC-4CH)

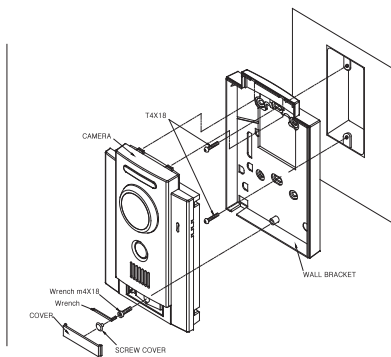
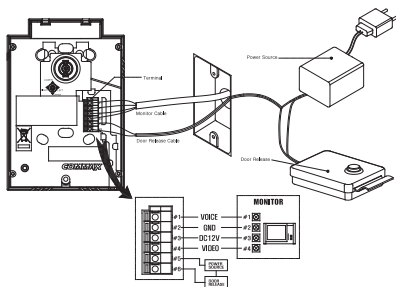

- Notes for installing

- Please keep the product away from a direct ray of the sun or strong reflected light.
(You may not get clear screen quality.)



7. Operation Description

1. Visitor call & monitoring

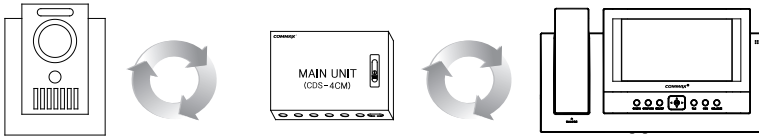

- Press **Call** button on camera to see the visitor's look with chime sound from the household monitor.
- If you want to talk, press the **TALK** button to communicate in hands-free mode.
- If you hold up handset, communication is available by handset.
- Press the **MONITOR** button to see condition of the door in standby state, and press the **RIGHT (▶)** button to see the screen of next camera.
 - ▶ At that time, the camera is not set as connecting with DIP S/W of main unit, that channel is passed.
- Pressing the **OPEN** button while talking or monitoring over the camera, then close the contact relay for about 4 seconds.
- Pressing the **REC./IMAGE** button while talking or monitoring over the camera, then store 1 cut at that moment.
- Press the **MONITOR** button to end while talking over the door camera by hands-free, put down the receiver to end communication while talking over handset.
- When visitors call simultaneously at more than 2 cameras, chose a camera you wish to talk by using the **UP/DOWN** direction and press the talk button.

2. Interphone function



- **This function is to call or to communicate the other room.**
- Press the **INTERPHONE** button to display **ROOM ID** on the screen.
- Place an arrow to call desired **ROOM** using **UP/DOWN** button and press the **ENT** button, then you can hear call sound (melody) in the responding **ROOM**.
- Press the **TALK** button or hold up the handset to communicate each other.
 - ▶ Own **ROOM** number is written in parenthesis and cannot be called. Ex.: [Room 1]
 - ▶ If Room ID set to reject interphone call receiving is called, "REJECT CALL" is displayed.
- In case of calling a room number without a video phone, "Unconnected Device" is displayed in OSD.
- In case the line is busy with another device, "Interphone Busy" is displayed.



7 Operation Description

3. Burglar function

This function is to execute burglar set by magnetic switch.

- Press the MENU/SET button and set Yes(Y) or No(N) with the right(\rightarrow) button in burglar set mode, and then the MENU is out after pressing MENU/SET button.
 - ▶ It is available only in case that the magnetic switch connected to the main unit is closed.
(Holding time: 60 sec)
 - ▶ If 'Y' is selected, red lights in all monitors is flashing simultaneously.
- If the burglar function is required after the set is completed, a holding time is needed and a siren sounds with OSD message. (Holding time to release: 30 sec)
 - ▶ In release, press the ENT button according to the OSD menu, restore is available only in case that the magnetic switch connected to the main unit is closed.

4. Review function

This function is to see the stored screen by manual or automatic.

- Press the REC./IMAGE button and then enter into Review mode with ENT button.
- Stored screens are showed per 6 screens and you can see 6 cuts in order with the RIGHT(\rightarrow) button.
- Place an arrow on 1 screen with the UP/DOWN(\uparrow , \downarrow) button to review it per 1 screen.
- Every 1 screen is reproduced and showed per 1 cut in order with the RIGHT(\rightarrow) button.

OSD:

1 screen

▶ 6 screen



OSD:

▶ 1 screen

6 screen



- Press the REC./IMAGE button and menu out finish
 - ▶ It is showed from the last stored screen and all 128 cuts are stored.
 - ▶ Please be noted that an additional screen to be stored after completion of 128 cut stores, the screen is removed from the first stored screen.



7 Operation Description

5. Product setting

5-1. Room ID set

Please set Room number to be designated in Interphone Call.

- Switch to Room ID set mode with MENU/SET button. Press the ENT button after placing an arrow on desired Room number with UP/DOWN(▲, ▼) or LEFT/RIGHT(◀, ▶)button, and then the Menu is out.

5-2. Interphone Call Rejection set

It is set when you don't want to receive the Call from the other Room.

- Switch to Inter. Reject call mode with MENU/SET button and select Yes (Y) or No (N) with RIGHT(▶) button, and then the MENU is out after pressing ENT button.

5-3. Time Adjustment

It is set to store the time when the screen is stored in the image memory.

- Switch to Time set mode with REC./IMAGE button with the DOWN (▼) and ENT button.

OSD:

Review
▶ Time set
Auto record
Del. Whole memory

09/mar/06 12:30:00
▲
Day set :09
• Complete: ENT



7 Operation Description

- Place an arrow(▲) at the point to be adjusted with LEFT/RIGHT(◀, ▶) button and adjust with UP/ DOWN(▲, ▼) button.
- A set is completed, press the ENT button to store, and then the Menu is out after pressing REC. IMAGE button.

5-5. Automatic recording

This function is to store 1 cut of momentary screen automatically when the visitor press the Call button at the door.

- Press the REC./IMAGE button and enter into Auto record mode with DOWN(▼) and ENT button. Then Select yes(Y) or no(N) with RIGHT(▶) button and then the Menu is out after pressing REC./IMAGE button.
- Switch to Time set mode with REC./IMAGE button with the DOWN (▼) and ENT button.

OSD:

Review
Time set
▶ Auto record
Del. Whole memory

Auto rec Y

- ▶ If the set is in "Y", automatic recording lamp(Green) located in upper part of the product is flashing. (the lamp of the other ROOM UNIT is also flashing at the same time)

5-6. Stored screen Deletion

This function is to delete all of unnecessary screen stored in the memory.

- Press the REC./IMAGE button and switch to Whole memory del mode with the DOWN(▼) and ENT button. Then select yes(Y) or no(N) with RIGHT(▶) button. All memory contents are deleted after pressing ENT button.

OSD:

Review
Time set
Auto record
▶ Del. Whole memory

Del. Whole memory Y
Push the enter



- ▶ The Menu is out after pressing REC./IMAGE button.

5-7. Screen Adjustment

- Press the MENU/SET button and switch to the screen adjustment mode after pressing ENT button.
- Pressing the ENT button show the finger picture(☞), and then place it to be required in adjustment mode with UP/ DOWN(▲, ▼) button and press the ENT button again.
- The level is increased or decreased with LEFT/RIGHT(◀, ▶) button and turn back to the previous menu after pressing MENU/SET button again.



7 Operation Description

OSD:

▲ ▼	ENT	◀ ▶	MENU / SET
CONTROL MENU	CONTROL MENU	CONTROL MENU	CONTROL MENU
Contrast			Contrast
Brightness			Brightness
Hue	Color	Color	Hue
☞ Color			☞ Color
Reset			Reset
Exit			Exit

- ▶ Please adjust other screen adjustment on the same way.
- To initialize the screen adjustment, please press ENTER button in RESET place, then it is changed to the initialized value that is set on production.

OSD:

CONTROL MENU	CONTROL MENU	CONTROL MENU
Contrast	Contrast	Contrast
	Brightness	Brightness
Brightness	Hue	Hue
	Color	Color
Hue	☞ Reset	Reset
	Exit	☞ Exit

- If all screen adjustment is completed, the MENU is out either pressing MENU/SET button in EXIT place or pressing the MENU/SET button.



8. Check point in trouble

If you think that the product has trouble, please first check below contents before you ask a repair.

Troubles	Check Point	Actions
<ul style="list-style-type: none">• The power supply is not on.• All works are stopped	<ol style="list-style-type: none">1.The power supply code is missing or not.2.The power supply switch (down) is off or not.	<ol style="list-style-type: none">1. Please connect the power supply cord2. Please turn on the power supply switch (down) pushing to the right.
<ul style="list-style-type: none">• A Call operation is not performed. (Door, Interphone function)	<ol style="list-style-type: none">1.The wiring between other units is connected correctly in good order or not.2. The wiring is missing or not.3. A Room id is set or not.	<ol style="list-style-type: none">1. Please refer to connection related page and manage.2. Please connect correctly to the terminal.3. Please refer to Room id setting related page.
<ul style="list-style-type: none">• The product does not produce the sound. (Call volume, Talk volume)	<ol style="list-style-type: none">1. A sound volume lies in minimum or not.	<ol style="list-style-type: none">1. Please adjust the sound volume properly turning to the right, as you want.
<ul style="list-style-type: none">• The screen is dark.• The screen is strange.	<ol style="list-style-type: none">1. There is a strong reflected light behind the visitor or not.2. The screen control is adjusted correctly.	<ol style="list-style-type: none">1. Please change the angle of camera lens.2. Please initialize the screen control. (Refer to setting related page)
<ul style="list-style-type: none">• Talking by handset is not performed. (only CAV-70B)	<ol style="list-style-type: none">1. The battery is discharged or not.2. A charging terminal is stained with foreign body or not.	<ol style="list-style-type: none">1. Make sure the battery is fully charged. (More than 5 hours)2. Please wipe clean on a dry cloth.



9. Specification

ITEM	CONTENTS(CAV-71B)
Wiring number	Main unit: 6 lines, Master: 6 lines
Rated voltage	AC100-240V, 50/60Hz
Talk method	Hands-Free: Voice switch method, Handset: wire(71B)
Display unit	17.78Cm(7") TFT-LCD
Call sound	Door (individual door): ring electronic chime 3 sounds twice repeatedly, Interphone: electronic melody sound
Power consumption	On standby: 4.4W
	On operating: 17W
Communication distance	MAIN UNIT to MASTER : 20m/ \varnothing 0.5(CAT. 5)
	MASTER to MASTER : 20m/ \varnothing 0.5(CAT. 5)
Talk channel	1 channel
Dimension	315(W) x175 (H) x53(D)
Weight	1.7kg
Temperature	0°C~ 40°C



Memo